



\$120 Capacity ChangeMaker



Operator's Manual

INTRODUCTION

Congratulations on the purchase of your new ChangeMaker. This ChangeMaker has been designed to give you many years of dependable service. It requires little maintenance and is easy to set up and operate.

READ THIS MANUAL COMPLETELY

Your ChangeMaker is designed to operate simply and reliably, but to take full advantage of your vendor, please read this owner's manual thoroughly. It contains important information regarding installation and operations, as well as a brief trouble-shooting guide.

EQUIPMENT INSPECTION

After you have received your machine and have it out of the box, place it on a secure surface for further inspection. **Note:** Any damages that may have occurred during shipping must be reported to the delivery carrier immediately. Reporting damages and the seeking of restitution is the responsibility of the equipment owner. The factory is willing to assist you in this process in any way possible. Feel free to contact our Customer Care Department with questions you may have on this process. It is important that you keep the original packaging for your vending machine at least through the warranty period. If your machine needs to be returned for repair, you may have to purchase this packaging if it is not retained.

Once you have your vendor located, we suggest that you keep this manual for future reference, or you can view this manual online at www.seagamfg.com. Should any problems occur, refer to the section entitled "COMMON QUESTIONS AND ANSWERS". It is designed to help you quickly identify a problem and correct it.

MANUFACTURER'S WARRANTY

WHAT IS COVERED:

Manufacturer warrants TO THE ORIGINAL PURCHASER ONLY that each item of equipment manufactured is free from defects in material and workmanship under normal use and service. Manufacturer's obligation under warranty shall be limited to repair or replacement, at our plant, of any parts of the equipment, which shall, within one year of the date of shipment to the original purchaser, be demonstrated to be defective. The original purchaser may obtain repair or replacement of the equipment under warranty by returning the defective item or entire vendor to the Manufacturer, freight prepaid.

WHAT IS NOT COVERED:

Manufacturer's warranty obligations DO NOT EXTEND TO OR INCLUDE installation expenses, vandalism, or difficulties resulting from failure to operate equipment in accordance with Manufacturer's instructions under competent supervision and difficulties due to changes in vended products, which are beyond the control of manufacturer.

SPECIAL NOTE: Manufacturer is not responsible for any loss of income due to a vending machine being out of service due to a warrantable item.

This warranty is in lieu of all the other warranties, expressed or implied, including the warranty of merchantability and fitness or use, and of all other obligations or liabilities on Manufacturer's part. Manufacturer neither assumes, nor authorizes any other person to assume for it, any other liability in connection with the sale of equipment manufactured by itself. This warranty shall not apply to equipment manufactured or any part thereof which is subject to accident, negligence, alteration, abuse, misuse, or damage in shipment. The term "original purchaser", as used in this warranty, shall be deemed to mean that person for whom the equipment is originally installed.

Manufacturer is not liable for any incidental, consequential or other damages of any kind whatsoever, directly or indirectly, arising from the use of the equipment whether based upon theories of contract negligence or tort.



For Service and Customer Care:
8:30 a.m. - 4:00 p.m. CST. Mon thru Fri
815.297.9500 ext 160
815.297.1758 Fax
email: customercare@seagamfg.com

700 Seaga Drive
Freeport, IL 61032 U.S.A.
seagamfg.com

Figure 1 - \$120 Capacity ChangeMaker

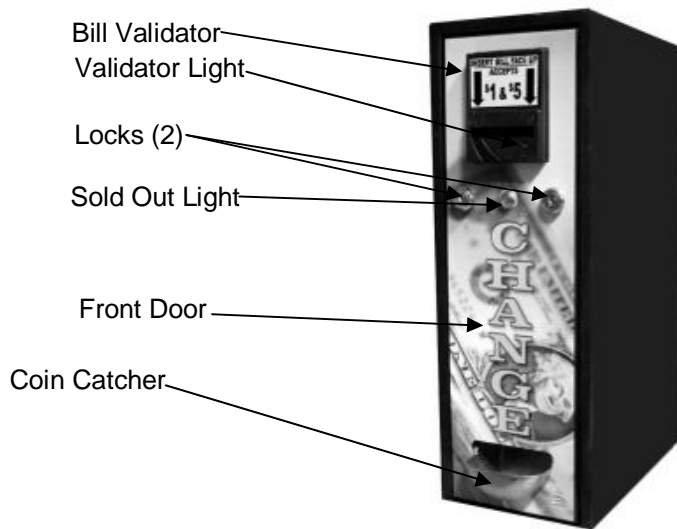

View with Front Door open and Coin Tube Assembly pulled forward

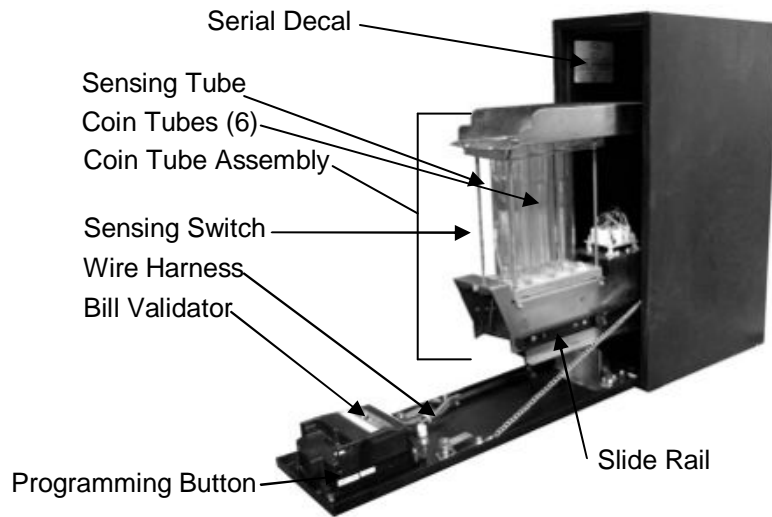

LOCK

Your ChangeMaker has two (2) Locks. To unlock the Front Door, turn left key counter-clockwise one-quarter turn and the right key clockwise one-quarter turn. The Front Door will now swing down to open. A chain attaches the Front Door to the Case for support. You will not be able to remove the key once the changer is unlocked.

MOUNTING

The ChangeMaker has three (3) plugged holes in the left-hand side of the Case for mounting. A drill, a 1/4" drill bit, and two (2) wrenches will be required. A mounting template for drilling holes is provided.

To Mount:

- a. Secure the template to the mounting surface once you have made sure that nothing will obstruct the drilling of holes or the placement of bolts.

- b. Drill holes. Discard Template.
- c. Unlock and open the Front Door.
- d. Pull Coin Tube Assembly forward. Disconnect the wires that connect the Coin Tube Assembly to the inside of the case. (See Removal of Tube Assembly) Note: The Coin Tube Assembly will still be connected to the Bill Validator. Remove the three (3) Plugs by pushing them out from inside the Case.
- e. Attach the ChangeMaker to surface with hardware appropriate to your application.
- f. Reinstall Coin Tube Assembly and reconnect wires.

SETTING SERVICE

Your \$120 Capacity ChangeMaker is factory preset to validate \$1 and \$5 bills, but it may also be set to validate \$1 only. To change the setting of your Bill Validator, a programming card must be fed through the bill validator opening as you would a bill. This programming card has areas darkened that instruct the bill validator which bills to accept and how many coins to give per dollar. An actual size programming card has been included at the end of this manual. This card may be photocopied but remember that it must remain the required size given. Do not reduce or enlarge.

To reprogram your ChangeMaker to accept \$1 bills only, cut out the programming card provided for this configuration on the dotted lines. Unlock and open the front door. The Programming Mode Button is recessed; you may need an object with a tip to press the button. Press the Programming Mode Button (Figure 2) ***quickly – DO NOT HOLD DOWN THE PROGRAMMING MODE BUTTON!*** The Bill Validator Light will then flash slowly. Insert the programming card face up, following the arrows and “Insert this end first” instruction. The card will cycle through the Bill Validator and return back to you.

Figure 2 – Programming Mode Button



Your ChangeMaker is now programmed. It is recommended that you perform a few tests with both a \$1 and \$5 bill to verify that the programming has been successful. The \$1 should vend change and the \$5 should be rejected if properly reprogrammed using the \$1 only card.

If the programming was not successful – Did you feed the correct card through? Was the card fed through the correct end first and face up? Did you remember to press the Programming Mode Button first? If you are not successful on your subsequent attempts, please contact Seaga Customer Care.

DELIVERY SYSTEM

The ChangeMaker's Delivery System consists of the Bill Validator, and the Coin Tube Assembly. The Coin Tube Assembly consists of the Coin Tubes, Sensing Switch, Slide Plate, and the Solenoid. The Bill Validator accepts bills and the Solenoid cycles the Slide Plate forward and back dispensing one (1) coin from each tube per cycle. The Solenoid will cycle once (1) for a \$1 and five (5) times for a \$5.

LOADING CURRENCY

CAUTION: Turn off and unplug your changer before loading or you could cause damage and void your warranty!

The ChangeMaker will dispense one (1) coin from each Coin Tube, so you must decide what change your customers will receive. The ChangeMaker will dispense tokens as long as they are standard quarter size.

1. For your customers to receive quarters only; load the first four (4) tubes with quarters and leave the remaining tubes empty.

2. For your customers to receive three (3) quarters, two (2) dimes and one (1) nickel; load three (3) of the large tubes with quarters, one (1) large tube with nickels, and the two (2) small tubes with dimes. (See Fig. 1)
 Special Note: It is important to load all tubes with an equal number of coins, to make sure that the coins are sitting flat in their tubes, and that the coins are free of defect and foreign matter.
 The left front Coin Tube also referred to as the Sensing Tube features a Sensing Switch that detects the presence of coins.
 Note: Always load quarters into the Sensing Tube. (See Fig. 3)

Figure 3 – Loading Coins

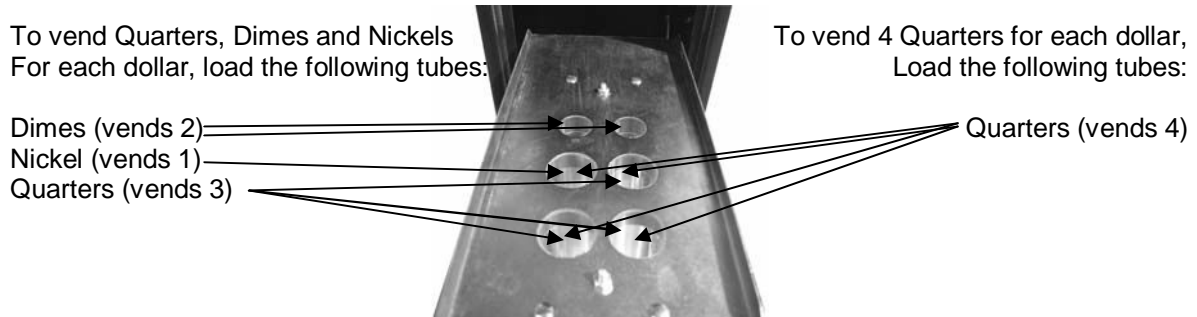
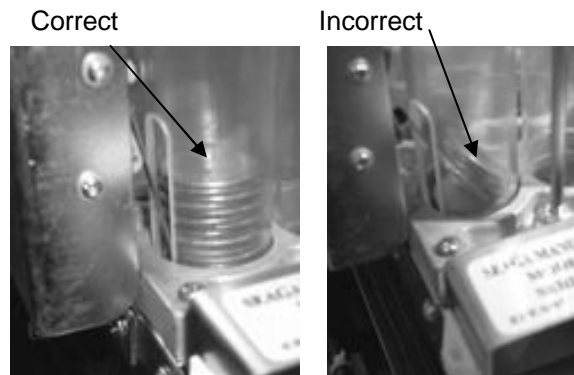

Figure 4 – Loading the Sensing Tube



BILL RETRIEVAL

Accepted bills are stacked randomly on the top of the Coin Tube Assembly. It is normal for some overflow to occur.

TUBE ASSEMBLY REMOVAL

It may be necessary to completely remove the tube assembly to reload or remove coins.

To remove the tube assembly from the cabinet:

- a. Disconnect the power source to the changer.
- b. Open the front door of the changer and pull the tube assembly forward. Disconnect the wire harnesses from along the left side of the door, inside the cabinet and at the validator.
- c. Pull the tube assembly forward until it stops.
- d. Unlatch the slide rails by first locating the releases on each side of the tube assembly. Disconnect by lifting the left lever up and pushing the right lever down. (See Page 3 for location of slide rails)
- e. The tube assembly can now be removed. It may be necessary to push the rails that are attached to the cabinet back in order to assist in the tube assembly removal.

SOLENOID AND SLIDE REMOVAL

To remove the Solenoid:

- a. Disconnect the changer from the power source.
- b. Remove Coin Tube Assembly
- c. Lift off circuit board while “pinching” each of the 4 corner pegs. Disconnection of the circuit board wiring is not necessary. If wiring needs to be disconnected for some reason, please make a note of the proper connection. (Fig. 3)

- d. With the circuit board removed, loosen and remove the solenoid screws and unplug the two solenoid wire plugs. Replace the solenoid following these steps in reverse order.

Figure 5 – Solenoid, side view with Circuit Board removed from pegs

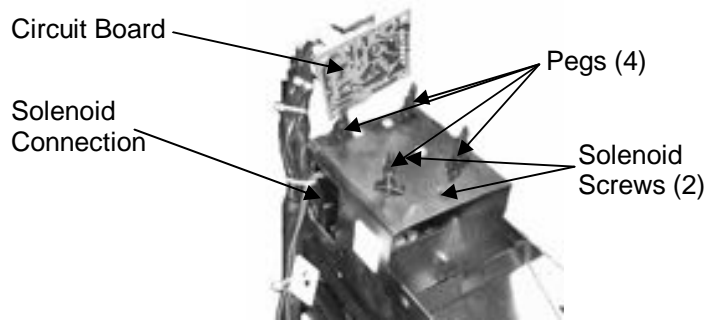

To remove the Slide:

- a. Disconnect the changer from the power source and empty coins.
- b. Remove Coin Tube Assembly.
- c. Remove the two (2) coin sensor switch screws and the four (4) Coin Tube Assembly screws. (See Page 3)
- d. Lift off the tube assembly. It may be necessary to push back on the slide, as the Solenoid spring may have tension on it.
- e. Remove the two (2) rod nuts, lift off the top tube assembly plate and remove the rods and coin tubes. (See Fig. 1)
- f. Remove the four (4) screws located in each corner of the aluminum tube block. Lift off tube block, exposing the slide and bottom plate.
- g. Lay the replacement slide on the bottom plate and insert the solenoid rod with spring back into the Solenoid. Reassemble the tubes and screws following these steps in reverse order.

CLEANING

The Coin Tubes may need to be cleaned periodically. To clean, you may blow out the tubes with canned air, which can be found in office and computer supply stores. Do not use liquids or chemicals on the ChangeMaker or on any part of the Bill Validator!

REPLACING THE BILL VALIDATOR

In the event that you need to replace your Bill Validator, your ChangeMaker is designed for easy replacement.

To Remove the Bill Validator.

- a. Unplug the ChangeMaker.
- b. Unlock and open the Front Door.
- c. Unplug the Wire Harness from the left side of the Bill Validator (Fig. 4)
- d. Press the Release Lever on the Bill Validator and lift it toward the Coin Hopper
- e. Slide the Bill Validator up to remove

Figure 6 – Removing the Bill Validator

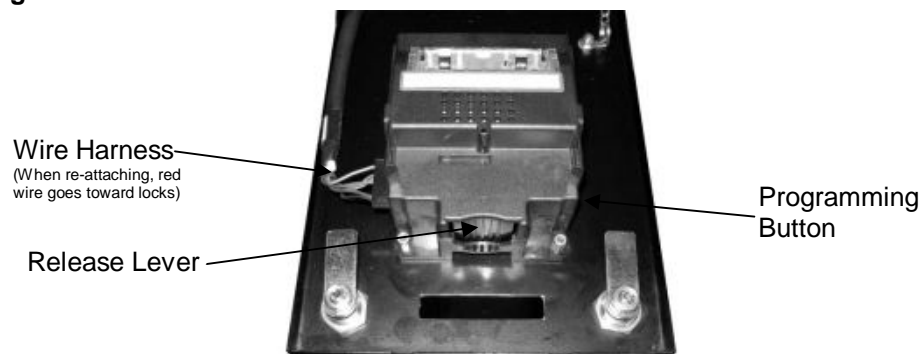

FUSE

On the inside of the ChangeMaker's case, located in the very back on the top, you will find a Red Fuse Cover. Inside there is a 6.3 amp / 250 volt, 5mm x 20mm Fuse that protects your ChangeMaker from power surges. (Fig. 6) An fuse comes factory installed, and an extra fuse is included for your convenience, attached to the top of the Coin Tube Assembly.

1. To replace the Fuse.
 - A.) Unplug the changer from the power source.
 - B.) Unscrew the Fuse Cover counter-clockwise and remove.
 - C.) Remove the old fuse and replace with new.
 - D.) Replace Fuse Cover and plug ChangeMaker back in.

Figure 7 – Fuse Replacement

(Inside back of Case)

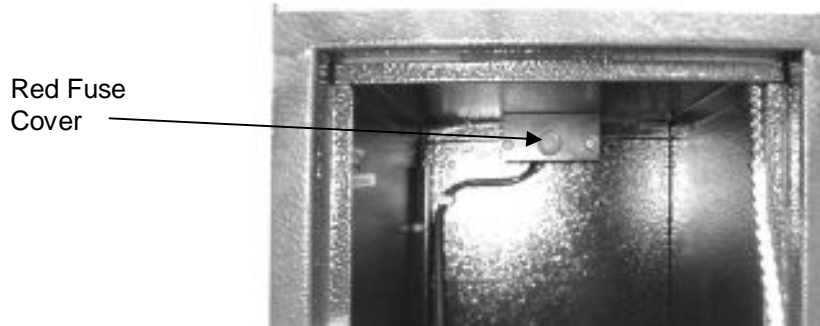

GENERAL

It is suggested that a toolbox accompany you to each of your locations. Suggested items for this toolbox would include a socket set, (up to a 1/2" socket size suggested) a wrench or pliers, a Phillips and a Standard screwdriver. Additional items would be a soft rag and perhaps a black marker. The marker is useful in touching up light scratches that may occur to your vendor.

COMMON QUESTIONS AND ANSWERS

- Q: The Validator Lights is not on
A: Check the level of Coins in the SensingTube
Check to make sure that the coins in the Sensing Tube are loaded properly (see Fig. 4)
Check the power source.
Check the Fuse.
Check the Wire Harness to make sure it is plugged into the Bill Validator.
Unplug the ChangeMaker, then wait one (1) minute and plug in. (This action will "reset" the ChangeMaker.)
Pull the Coin Tube Assembly out completely. With the ChangeMaker plugged in, look for illuminated red lights on the Circuit Board. If these are not illuminated, contact Customer Care.
- Q: How do I remove a jammed bill?
A: Open the Bill Validator per "REPLACING" and remove the jam.
- Q: Bill will not feed into, or is not accepted by the Bill Validator.
A: Is the Validator light on?
Yes: Make sure the bill is not soiled, damaged, or defaced.
Clean the Bill Validator.
Make sure the Bill Validator is closed completely
Make sure the Sensing Tube has coins.
Check for a jam.
Check the Wire Harness connections.
Check to see that the coins are laying flat in the tubes.
If all suggested checkpoints have been confirmed, contact Seaga Customer Care (see page 2).

- Q: My ChangeMaker is dispensing the wrong amount of coins.
A: Make sure that the coins are not obstructed, warped, bent or stuck together.
Make sure that the Coin Tubes are loaded correctly.
Check to see if each of your coin tubes are dispensing evenly.
Check to see if the Sensor Switch is “holding up” the coins.
In this case, an adjustment to the switch may be necessary.
This can be adjusted in a couple of ways:
1.) Pull the switch housing away from the tubes slightly.
2.) Remove the switch housing and put a slight downward bend on the arm.
Finally, the coin slide may not be ejecting properly.
Check for jams in the coin slide located underneath the tubes.
- Q: All coins do not slide down the ramp to be retrieved.
A: This ramp can become sticky over time. Spray a little glass cleaner on the ramp and wipe off with a clean cloth.
- Q: My tubes and slide area seem dirty and aren't working properly as a result.
A: Empty out your coins. Activate the sensor switch by sliding a thin tool of some sort in-between the sensor tube and the switch. This will activate the switch and will allow a bill to be accepted by the validator. Spray glass cleaner into each tube and allow it to drain down into the slide area. Run a few bills through the validator. Finish the cleaning process by wiping off the ramp.
- Q: My validator takes in the bill but no coins dispense.
A: Check to see if the solenoid is plugged in (see Fig. 5).
Check the slide to see if it is free from jams.
Check the connection of the solenoid rod to the slide. The hole in the slide may be damaged as a result of a coin jam, throwing off the timing of the slide plate, causing an improper vend.
- Q: How do I access the slide?
A: See Solenoid and Slide Removal section of this manual.

PROGRAMMING CARDS

Carefully cut straight along dotted lines to create a programming card to change your machine to accept \$1 bills only. This page may be copied at 100% (no reduction or enlargement). Cards must remain size shown for proper recognition in the Bill Validator.

To accept \$1 only

To accept \$1 and \$5

